



Littlewood

Catalogue 2019



Index

1	Index	27-28	Gate Fittings
2	Introduction	29	Decking Introduction
3	Closeboard Fencing	30-31	Decking Material
4	Closeboard Fencing Explained	32	Plates / Joists & Sleepers
5	Posts - Added Value Work	33-34	Landscaping Products
6	Standard Fence Post	35-36	Artificial Grass
7	Fence Post Supports	37-38	Garden Furniture
8	Post Savers & Aggregates	39	Sheds
9-10	Closeboard Material	40	Chestnut Products
11	Palisade (Picket Fencing)	41-42	Ritchie
12	Bird Mouth & Sawn Post & Rail	43	Machine Rounds
13	Larch Lap Panels	44	Stock Fencing, Barb / Line Wire & Wire Netting
14	Closeboard & Palisade Panels	45	Concrete Posts
15	Trellis	46	Concrete Gravel Boards & Spurs
16-17	Decorative Panels	47	Chain Link
18	Gates Introduction	48	Angle Irons
19	Palisade / Picket Gates	49-50	Steel Palisade & Mesh Fencing
20	Closeboard Gates	51-52	Fabrication Workshop
21	Larch Lap Gates	53-54	Fixings
22	TGV Gates	55-56	Approved Installers
23	Nunningham Field Gate	57	Tools
24	Beechdown Field Gate	58	Company Policies
25	Driveway Gates		
26	Metal Field Gates		



Artificial Grass
Page 35-36



Driveway Gates
Page 25



Fabrication Workshop
Page 51-52

All prices represented in this catalogue include VAT @ 20%
All prices correct at time of printing. Prices may change without prior notice.



Littlewood Sales has become the “Go to” fencing and agricultural supplies centre for Sussex and the South Coast. Offering exceptional value, quality and service the retail and trade outlet caters for all your fencing, landscaping, equestrian and agricultural product needs.

With many years’ experience the Littlewood Sales Team are on hand to provide advice on all products, tools and fixings to help get your project up and running.

Based in Battle, East Sussex we operate from a 5 acre site offering a full range of quality and stylish products.



Do you require delivery?

Littlewood offer free local delivery for orders over £240 inc VAT.

Hi-ab deliveries may incur an additional charge.

For more details please discuss with a member of staff.



Closeboard Fencing

Closeboard Fencing combines strength, versatility and appearance to help create the perfect garden border. Closeboard fencing is constructed on site and can be erected in various heights and bay lengths with additional options such as capping / trellis. It's available in a brown or green treated finished.

We have on site morticing facilities to create exactly what is required for your garden fence. For free no obligation quotes please call or email us and one of the sales team will be happy to assist, whether it is supply only or if you require installation * as well.

* For domestic installations, we can provide the details of trusted local installer in your area. Please see pages 55-56.

Bay Price Guideline

Prices below for guideline purposes only. Prices all in Green pressure treated timber (Brown available at an additional cost). Bay consists of 1 x Flat Top Morticed Post, 1 x Gravel Board, 1 x Gravel Stump, 2 x Timber Cleats and the relevant arris rails (ended) and feather edge.

		1.8m	2.4m	3.0m
Finished	3ft	£39.89	£49.71	£55.60
Height Inc.	4ft	£45.06	£56.69	£64.22
Gravel Board	5ft	£55.39	£69.60	£78.86
	6ft	£64.74	£82.41	£93.24

Closeboard Fencing Explained

Closeboard with Capping

Our most popular finish for closeboard fencing. The capping rail sits on top of a support rail (counter rail) to make the fence more aesthetically pleasing. Post is finished with a standard round top.



Closeboard (No Capping)

Standard morticed Closeboard without capping. Post is finished with a half back weather.

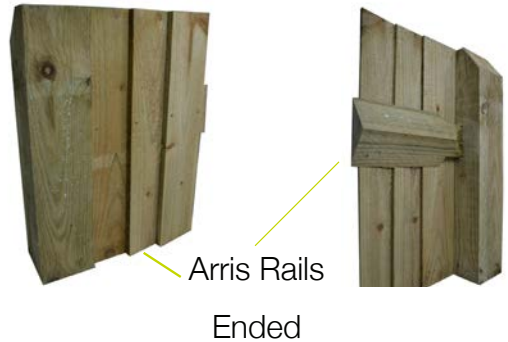

Closeboard using Brackets

Instead of morticed posts, you can use arris rail brackets for a quick repair/install. Available in Galv or Brown Finish.



Posts - Morticing and Added Value Work

The following mortice prices and added value work is priced per post:

The diagrams on the right hand side are a small guide as to how the posts can be morticed to suit the layout of your garden

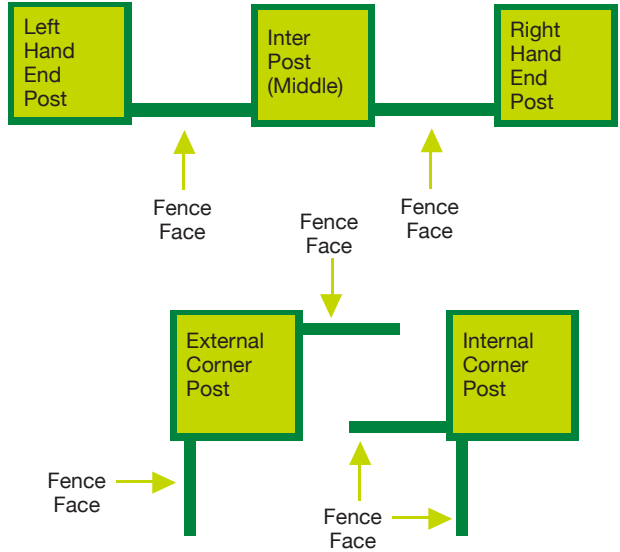

No Counter Rail and Capping

Up to 1.35m (4'6") Finish Height
 - Including Gravelboard £1.12
 Above 1.35m (4'6") Finish Height
 - Including Gravelboard £1.66

With Counter Rail and Capping

Up to 1.35m (4'6") Finish Height
 - Including Gravelboard £1.66
 Above 1.35m (4'6") Finish Height
 - Including Gravelboard £2.21

Added Value Work

Back Weather £0.64
 1/2 Back Weather £0.55
 2 Way Weather £0.95
 4 Way Weather £1.56
 Round Top £0.80
 Double Round Top £1.56



Standard Fence Post



Green Fence Posts

	1.8m	2.1m	2.4m	2.7m	3.0m	3.6m
50 x 50mm	/	/	/	/	£4.50	/
75 x 75mm	£6.10	/	£8.11	/	£10.16	/
100 x 75mm	/	/	£10.81	/	/	/
100 x 100mm	£10.81	£12.62	£14.41	£16.21	£18.03	£21.63
125 x 100mm	£13.51	£15.75	£18.03	£20.79	£22.53	£27.03
125 x 75mm	£10.13	£11.83	/	/	/	/
150 x 75mm	£12.18	£14.17	£16.21	/	/	/
150 x 100mm	/	/	£21.63	/	/	/

Brown Fence Posts

	1.8m	2.1m	2.4m	2.7m	3.0m
50 x 50mm	/	/	/	/	£4.95
75 x 75mm	£6.39	/	£8.52	/	£10.65
100 x 100mm	£11.06	/	£15.12	£17.04	£18.93

Stocked items priced above. If other sizes are needed, please get in touch with a member of our sales team.

Prepared Posts

Timber can be prepared on site using our planer - please note all work is done to order.

Section Size	
Under 125 x 125mm	£4.80 per post
Over 125 x 125mm	£7.80 per post

Fence Post Supports

Bolt Down

75mm x 75mm Galv	£10.86
100mm x 100mm Galv	£13.58



Drive - In Spike

75mm x 75mm Galv	£13.47
100mm x 100mm Galv	£19.33



Arris Rail Brackets

Arris Rail Bracket Galv	£1.15
Arris Rail Bracket Brown	£1.94
Arris Rail Bracket for concrete posts	£2.14



Post Savers

The use of Postsaver sleeves will significantly prolong the life of your wooden fence posts, giving you substantial long term cost savings. This saves you the hassle and expense of ongoing fence maintenance and repair.

Post Saver	
75 x 75mm	£1.22
100 x 100mm	£2.04
125 x 100mm	£2.06
125 x 125mm	£2.42
150 x 150mm	£2.87
175 x 175mm	£3.60
200 x 200mm	£3.68

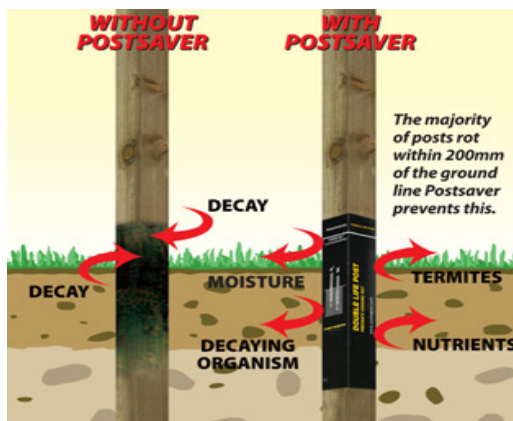

Aggregates



Post Mix 20 kg	£6.00
Cement 25 kg	£8.11
Ballast 25 kg	£1.99
Ballast Bulk Bag	£53.00
Sharp Sand 25 kg	£1.99
Building Sand 25 kg	£1.99
Pea Beach 25 kg	£2.38

Closeboard Material

Arris Rails



Arris Rails
Unended



Arris Rails
Ended

Item	Green	Brown
Arris Rails - 1.83m	£3.23	£3.38
Arris Rails - 2.4m	£4.24	£4.43
Arris Rails - 3.0m	£5.27	£5.54
Arris Rails - 3.6m	£6.31	/
Arris Rails Ended - 1.83m	£4.40	£4.62
Arris Rails Ended - 2.4m	£5.36	£5.65
Arris Rail Ended - 3.0m	£6.31	£6.60

Gravel Board 150mm x 22mm



Gravel Board

Item	Green	Brown
Gravel Board - 1.8m	£3.72	£3.90
Gravel Board - 2.4m	£4.86	£5.14
Gravel Board - 3.0m	£6.60	£6.39
Gravel Board - 3.6m	£7.26	£7.68

Cleats / Stumps / Counter Rail & Capping

Item	Green	Brown
Cleats 150mm - 65mm x 32mm	£0.48	£0.49
Stump 600mm - 50mm x 50mm	£0.97	£1.04
Counter Rail - 3.0m - 65mm x 32mm	£3.74	£3.93
Capping - 3.0m - 65mm x 38mm	£4.78	£5.02
Motorway Rail - 3.6m - 87mm x 38mm	£7.08	£6.44



Cleats



G Stumps



Capping

Feather Edge 100mm x 22mm 2ex

Item	Green	Brown
Feather Edge - 0.9m	£0.66	£0.68
Feather Edge - 1.05m	£0.78	£0.81
Feather Edge - 1.2m	£0.91	£0.93
Feather Edge - 1.35m	£0.93	£1.09
Feather Edge - 1.5m	£1.13	£1.18
Feather Edge - 1.65m	£1.24	£1.31
Feather Edge - 1.8m	£1.29	£1.36
Feather Edge - 1.95m	£1.46	/
Feather Edge - 2.1m	£1.59	/
Feather Edge - 2.4m	£1.81	£1.87



Feather Edge

Feather Edge 150mm x 22mm 2ex

Item	Green	Brown
Feather Edge - 3.0m	£3.11	£3.44
Feather Edge - 3.6m	£3.72	£4.12



Palisade (Picket Fencing)

Palisade Fencing combines strength and a decorative appearance.

Palisade Fencing is constructed on site and can be erected in various heights and bay lengths enabling you to create your perfect garden fence.



We have on site morticing facilities to create exactly what is required for your garden fence. For any assistance on pricing up Palisade Fencing please call or email us and one of the sales team will be happy to assist, whether it is supply only or if you require installation * as well.

*For domestic installations, we can provide the details of trusted local installers in your area. Please see pages 55-56.

Size / Type	Green	Brown
22mm x 100mm x 1.8m	£2.29	/
22mm x 100mm x 2.4m	£3.09	/
22mm x 100mm x 3.0m	£3.85	/
22mm x 100mm x 3.6m	£4.64	/
22mm x 75mm x 0.9m Flat Top	£0.85	£0.89
22mm x 75mm x 0.9m Round Top	£1.23	£1.27
22mm x 75mm x 0.9m Pointed Top	£1.14	£1.18
22mm x 75mm x 1.2m Flat Top	£1.14	£1.18
22mm x 75mm x 1.2m Round Top	£1.52	£1.56
22mm x 75mm x 1.2m Pointed Top	£1.43	£1.47
22mm x 75mm x 1.8m Flat Top	£1.72	/

Bird Mouth Posts & Rail

(These prices below are in Green timber)

		0.9m High	1.2m High
100mm x 100mm Bird Mouth Post		£6.32	£8.02
3" BZP Bird Mouth Strap	£3.04	75mm x 75mm x 3m Post	£10.16
4" BZP Bird Mouth Strap	£3.26	100mm x 100mm x 3m Post	£18.03



Sawn Posts & Rail

(These prices below are in Green timber)

	1.8m	2.1m
125mm x 75mm	£10.13	£11.83
125mm x 100mm	£13.51	£15.75
150mm x 75mm	£12.18	£14.17

	3.0m	3.6m
87mm x 38mm Motorway Rail	/	£7.08
100mm x 50mm Plate	£8.74	£10.51
75mm x 50mm Plate	£6.72	

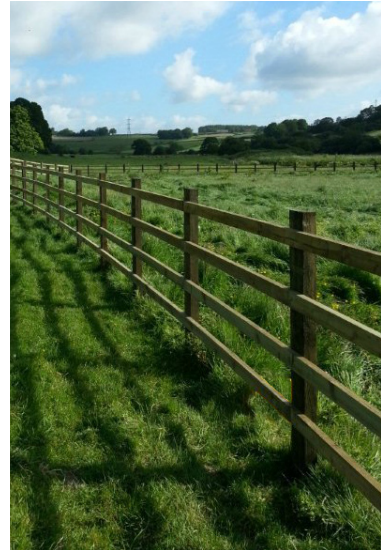

Panels

Here at Littlewood we stock a range of different fence panels to help complete a garden project. Choose from Closeboard, Larch Lap, Palisade, Trellis or Decorative panels.

Many sizes are kept in stock, however we also have the facilities to manufacture a range of custom sizes. Please speak to a member of the sales staff to enquire about size and availability.



Larch Lap Panels

Larch Lap Panels are a standard garden fence panel.

At Littlewood fencing, we hand make all our Larch Lap Panels using pressure treated Waney Edge Slats, 38 x 16 mm Battens and finished with capping.

Our panels are also made with battens on both sides for added strength and durability.

Size	Green	Brown
6ft x 3ft	£18.56	£19.39
6ft x 4ft	£21.74	£23.00
6ft x 5ft	£25.08	£26.50
6ft x 6ft	£28.91	£31.02

Special sizes are available to order



Closeboard Panels

Closeboard panels are a quick and easy way to get the appearance of traditional Closeboard Fencing.

These panels are a stronger alternative to Larch Lap panels.

Constructed with 75 x 32 mm Horizontal Rails, 32 x 38 mm Vertical Battens, then clad with 4" Feather Edge boarding and finished with a thicker top cap.



Special sizes are available to order

Size	Green	Brown
6ft x 3ft	£27.98	£30.25
6ft x 4ft	£35.41	£38.34
6ft x 5ft	£43.45	£46.43
6ft x 6ft	£48.50	£51.48

Palisade Panels

Palisade fencing panels (also known as Picket Fencing) allows you to mark out your garden boundary without obstructing views. Furthermore the gaps allow wind to pass through, which reduces the wind resistance of the panel.



At Littlewood Fencing, these panels are constructed to order, with a choice of flat top, pointed top or round top palisades.

Size / Type	Green	Brown
6ft x 3ft	£27.45	£28.55
6ft x 4ft	£31.85	£32.95

All Panels are made to order. Special sizes on request

Trellis

Trellis panels can be used for various applications, marking out a garden boundary, helping to create a wall display, providing a frame for climbing plants or even dividing a garden into sections.

We construct our own trellis panels using a quality treated timber batten (38 x 19mm) to create robust trellis panels to withstand the elements. Available to be manufactured in different shapes, styles and sizes to create your perfect trellis design.

Rectangular Trellis



Diamond Trellis



	6x1	6x2	6x3	6x4	6x5	6x6	10x1	10x2
Square	£10.69	£15.54	£18.76	£27.95	£27.97	£34.40	£15.62	£23.15
Diamond	£28.02	£36.37	£39.59	£47.12	£52.58	£58.15	£45.66	£54.16

All measurements are in feet
Diamond Trellis is constructed to order

Decorative Panels

Decorative Panels are stylish and elegant panels that bring any garden to life. They also look great around surrounding decked areas.

San Remo Omega Panel with Trellis

Horizontal slatted panel for the lower part, diamond swish top trellis at the top.

1.83m x 1.6/1.8m - £70.00

1.83m x 0.99/1.2m - £61.99



San Remo Bowtop Gate with Trellis

0.90m x 1.59/1.80m - £65.99

Fino

Our Fino continental panels feature a unique design with horizontal, hit and miss boards providing privacy and style. Manufactured from high quality treated timber, the Fino panel can give your garden a breath of fresh air.



1.8m x 1.8m - £89.90

Decorative Trellis Panel

Decorative trellis panels are great for screening areas of your garden or being used as a decorative backdrop for climbing plants. Various trellis spacings and styles available.



Cordoba Panel

With striking, vertical pointed pales, our new Cordoba Panel is totally unique and allows light and wind to go through the panel, while still securing your boundaries. Manufactured from high quality, pressure treated timber, the Cordoba Panel will make your garden stand out.



1.8m x 1.8m - £83.75

1.8m x 0.9m - £45.55

Structura

These panels are manufactured from ribbed softwood boards, and are ideal to be used for sectioning your garden or a perimeter fence. The structure of the panel allows wind to pass through, reducing the strain on the posts.



1.8m x 1.8m - £49.10

Many more styles of decorative fence panels available.
Speak to a member of the sales team for more information.

Gates

Gates are an essential part of all garden boundaries, whether it is a simple side gate or a driveway entrance gate. Here at Littlewood Fencing, we are able to provide a professional and quality service, helping you to create your bespoke gate. All our handmade gates are constructed using pressure treated timber for extra durability against the weather.

We have the knowledge and expertise to get your perfect custom made gate. All you have to do is get in touch with a member of the sales team and they'll help with any queries on your new gate.



Palisade / Picket Gates

Palisade gates are an alternative if you want to keep your garden open and let wind and light through while still marking out your boundary. These gates sit perfectly within a run of timber palisade fencing or panels.



- Handmade on Site
- Bespoke sizes made to order
- Softwood pressure treated timber, Green or Brown
- Available in Sawn or Prepared Timber
- Prices included Flat Top, Pointed or Round Top Pales
- 70 x 45mm Stiles, 70 x 30mm Crossbraces

Up to:	0.9m High	1.2m High	1.8m High
0.9m Wide	£54.00	£57.60	£78.00
1.2m Wide	£60.00	£60.00	P.O.A

Other sizes and additional customisation options are available, such as bow top, cladding both sides, etc. Please ask in store for details.

Closeboard Gates

A closeboard gate could be the perfect finishing touch for your garden. Used in a run of closeboard fencing or panels, on its own as a personal side gate, or even as a driveway entrance gate.



- Handmade on Site
- Bespoke sizes made to order
- Softwood pressure treated timber, Green or Brown
- Feather edge rebated into framework
- Strong framework used as standard (95x45mm Stiles, 90x30mm Crossbraces)

Up to:	0.9m High	1.2m High	1.8m High
0.9m Wide	P.O.A	P.O.A	£72.00
1.2m Wide	P.O.A	P.O.A	£78.00

Other sizes and additional customisation for example Bow top, counter rail and capping and fully framed gates are available.
Please ask in store for details.

Larch Lap Gates

Littlewood Fencing are introducing the Larch Lap gate to our gate range.

This gate will blend in perfectly into a run of larch lap panels.



- Handmade to order on site
- Softwood pressure treated timber, Green or Brown
- Slats rebated into framework and then covered with a batten for a quality finish
- Strong 'A' frame on back for additional strength
- Capping included in the price

Up to:	0.9m High	1.2m High	1.8m High
0.9m Wide	P.O.A	P.O.A	£72.00
1.2m Wide	P.O.A	P.O.A	£78.00

Other sizes are available. Please ask in store for details.

TGV Gates

If you're looking for a striking gate without sacrificing strength and durability, then tongue and groove is what you're looking for.

These gates are primarily made for entrance pathways or driveways due to their presence and robust construction.



- Handmade on site
- Bespoke sizes made to order
- Softwood pressure treated timber, green
- TGV rebated into framework
- Strong framework used as standard (95x45mm Stiles, 90x30mm Crossbraces)
- Optional 70 mm thick framework on request

Up to:	0.9m High	1.2m High	1.8m High
0.9m Wide	P.O.A	P.O.A	£96.00
1.2m Wide	P.O.A	P.O.A	£108.00

Other sizes and additional customisation for example Bow top, counter rail and capping and fully framed gates are available.

Please ask in store for details.

Timber Field Gates

Handmade wooden Field Gates manufactured on site

Timber Field gates are very popular with both the farming community and the general public. These gates can be constructed from different types of timber and also different styles.

Nunningham Gate



- Handmade on Site
- Softwood pressure treated timber (Hardwood also available)
- Stainless Steel Nuts & Bolts
- Planed finished timber with detail chamfering on Stiles and Top Rail
- 110x70mm Stiles and Top Rail
- 69x19mm Mid Rail & Braces
- Universal Hang as Standard, Handed gates available to order

Prices

0.9m	1.2m	1.8m	2.4m	2.7m	3.0m	3.6m
£91.20	£100.80	£124.80	£142.80	£153.60	£165.60	£186.00

Other sizes are available, please ask in store for details.

Beechdown Gate

- Softwood pressure treated timber
- Stainless Steel Nuts & Bolts
- Curved style to give the gate a unique look
- Planed finished timber with detailed chamfering on Stiles and Top Rail
- 120x70mm Hanging Stiles, 70x70mm Closing Stile and 120x70mm Tapered Top Rail
- Solid bottom rail built in ready for optional automation
- 69x19mm Mid Rail & Braces
- Hand made to order on site in any size from 0.9m up to 3.6m



Prices

0.9m	1.2m	1.8m	2.4m	2.7m	3.0m	3.6m
£122.40	£129.60	£156.00	£182.40	£196.80	£206.40	£230.40

Other sizes are available, please ask in store for details.

Gate Posts

Treated timber gate posts for hanging / shutting your gates. Round topping and 4 way weathering is also available at an additional extra.

	2.1m	2.4m	2.7m	3.0m	3.6m
125x125mm	£22.04	£25.18	£28.34	£31.48	£37.78
150x150mm	£31.75	£36.29	£40.84	£45.37	£54.44
175x175mm	£43.26	£49.43	£55.62	£61.79	/
200x200mm	£56.51	£67.27	/	£80.74	£96.90

Gate Post Round Topping = £4.20

4 way weathered 125-150 = £4.68 4 way weathered 175-200 = £9.36

Driveway Gate

At Littlewood Fencing we have expert craftsmen to help design and create your new driveway gate.

Available in softwood or hardwood timber with various styles to choose from. Our gates are custom hand made so can accommodate any requirements you may have.

For pricing and more information on designs and styles available please speak to a member of our sales team.



Metal Field Gate



- Hot dipped galv finish
- Robust design
- Design to reduce the risk of tail or ear-tag traps
- 'Brushed' hanging end
- Internal venting to the structure
- Supplied with 2 adjustable eye bolts
- 20mm spring bolt

10ft	12ft	15ft
£69.94	£88.51	£96.06

Square Post Hanging	£45.28	Square Post Shutting	£45.28
Bolt on D-Loop	£18.30	Two Part Gate Kit	£59.04



Gate Fittings

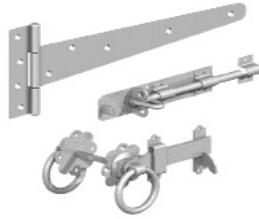

Side Kit A

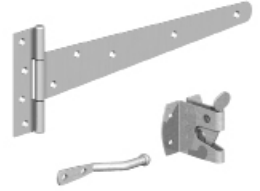

Side Kit B

We can offer a wide range of ironmongery ranging from hinges, bolts, field gate fittings and many more. Available in different styles and finishes. For a complete range, speak to a member of our sales team for a brochure. Below are just some of our popular fittings.

Side Kit A	£33.64	Side Kit B	£18.17
18" T-Hinges	£9.80	Large Auto Catch	£6.33
6" Ring Latch	£10.74	Medium Auto Catch	£3.59
6" Brenton Pad Bolt	£4.74	Heavy Hasp & Staple	£14.97
Heavy Suffolk Latch	£11.76	6" Cabin Hook	£4.04

All the above fittings priced for galvanised finish.

Other sizes and finishes are available.

Heavy Gate Fittings



Standard
Hook & Bands



Adjustable
Hook & Bands



Heavy Reversible
Hinges

	18"	24"	30"	36"
Standard Hook & Band	£17.19	£26.37	£38.08	£40.79
Adjustable Hook & Bands	£34.64	£38.83	£48.66	£66.33
Heavy Reversible Hinges	£23.61	£35.92	£48.66	£58.68

All the above fittings priced for Galvanised finish.

Other sizes and finishes are available.

Long Throw Lock



Long Throw Lock (50mm)	£44.07
Long Throw Lock Pull Handle	£15.55

Alternative Gate Fittings

We can also supply alternative gate fittings in a range of finishes. Gate Signs & Numbers, alternative locks, Self Closing Hinges & Many More. Grab a full catalogue in Store.



Field Gate Fittings

Field Gate Hinge Set

(12", 18" & 24")	£28.20	Hook to Bolt	£8.78
Self locking Gate Catch	£15.17	Hook to Drive	£5.56
Loop Over	£13.31	Hook on Plate	£7.51
Spring Catch	£18.21	Drop Bolt 18"	£14.25

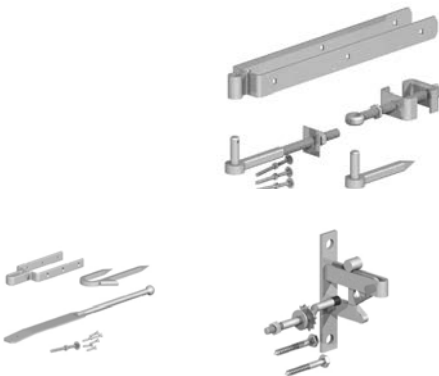

Field Gate Hinge Set



Spring Catch

Self Locking Gate Catch

Loop Over

Drop Bolt 18"

Decking

Timber decking can expand your home and outdoor environment, providing a place in nature, custom built for relaxation. Timber decks serve as an invitation to play, to enjoy peace and quiet, to relax, to slow down the pace of life, to bask in the sunshine or to breathe in the night air. They are an excellent place to meet with friends and family over a BBQ or garden party.

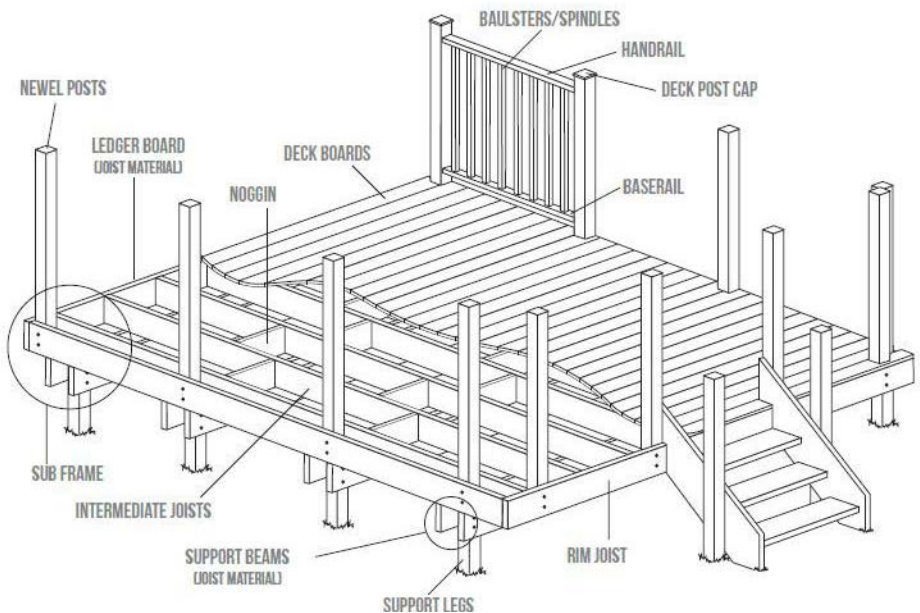

Decking Material

Decking Boards (ex 150 mm x 32 mm)

Item	Price
Decking - 3.6m	£10.16
Decking - 4.8m	£13.56

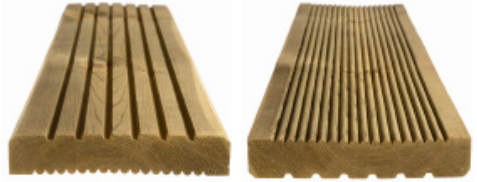

Reversible deck board with two different profiles

Post

Item	Price
95mm x 95mm X 1.8m Decking Post (Double Round Top)	£17.17



Decking Post (Optional routing)

Spindles

Item	Price
900mm Chamfered Spindles	£2.22
1.2m Chamfered Spindles	£2.34
900mm Turned Spindles	£2.54



Turned Spindles



Chamfered Spindles

Hand Rail

Item	Price
50mm x 100mm x 3.6m	£17.17
38mm x 88mm x 4.5m Reversible hand / base rail	£16.63



Hand Rail



Reversible Hand Rail

Decking Spacers

Item	Price
3.0m Decking Spacer	£3.44



Spacer Decking Material **30**

Screws

Item	Price
65mm Decking Screws (200 Box)	£8.82
65mm Decking Screws (1000 tub)	£43.80
90mm Timberfast Screws	£0.35
140mm Timberfast Screws	£0.57
190mm Timberfast Screws	£0.82
240mm Timberfast Screws	£1.11



Decking Screws



Timberfast Screws

Decking Rope

Item	Price
Manila Decking Rope 28mm (8m Roll)	£32.56
Polyhemp Decking Rope 28mm (8m Roll)	£48.44



Manila Decking Rope



Polyhemp Decking Rope

Anti Slip Grips



Transform your decking into an anti-slip surface which is usable all year round and retain the natural charm of the timber decking.

£59.40

Inc 25 x 1m strips + Adhesive

Metal Spindles

Arc Spindles

800mm long

P.O.A

(Pack of 5)



Baroque Spindles

800mm long

P.O.A

(Pack of 5)



Plates / Joists

Size	Length	Green	Brown
75mm x 50mm	3.0m	£6.72	/
100mm x 50mm	1.8m	£5.28	£5.33
100mm x 50mm	2.4m	£7.00	/
100mm x 50mm	3.0m	£8.74	£9.17
100mm x 50mm	3.6m	£10.51	/
100mm x 50mm	4.8m	£14.01	/
150mm x 50mm	3.6m	£15.78	/
150mm x 50mm	4.8m	£21.25	/



Sleepers

Softwood - Treated Green

225mm x 125mm x 3.0m	£50.69
200mm x 100mm x 2.4m	£25.60
Grade A Reclaimed Sleepers	£31.58



Oak

200mm x 100mm x 2.4m	£ P.O.A
----------------------	---------



Landscaping Products

Paving Slabs

Littlewood Fencing are now able to supply top quality paving slabs and natural stone slabs.



Two-Tone Sawn

Raj Calibrated



For pricing and more information and to see our full range, please speak to a member of our sales team

Coloured Aggregate



Black Ice
£4.85



Flamingo Chippings
£6.01



Scottish Cobbles
£5.99

Large bags Approx 20kg

Other Coloured Aggregates also available.

Speak to our sales team for a full range.

Fabric

Weedtex is a standard duty weed control fabric offering very effective weed suppression for many different applications. Weedtex allows nutrients (including liquid feed and fertilisers), water and air into the soil to maintain its goodness and promote plant growth, whilst preventing weeds getting the daylight they need to grow.



Landscaping Fabric 1m x 15m £11.26

Landscaping Fabric 2m x 25m £24.12

Soft Landscaping Products

Littlewood Fencing now offer professional soft landscaping products for your garden.

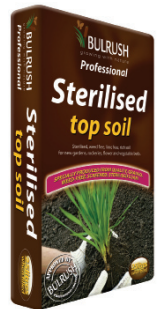

Decorative Bark Chips 70L £5.58

Grow Bag 33L £2.52

Top Soil 25L £3.58

Multi-Purpose Compost 60L £4.15



Littlewood Fencing are now an official supplier of 'ArtifiicalGrass.com'. We hold two types in stock but there are many more styles available. Please enquire in store for more details.



Quest 30mm

A great quality, affordable solution for your lawn

Quest 30mm offers warm olive tones to create a natural looking and practical space all year round.

Quest is suitable for lawns, balconies & roof terraces, flat roofs, traffic islands, play areas and leisure, domestic and commercial projects.

4m x 1m = £76.75



Valour 30mm

A bold and brilliant turf with a V shape blade

The V shape blade of Valour 30mm gives it strength to stand up to all activities.

Valour is available in 2m and 4m widths to any length (to the nearest 100mm). Maximum roll size is 4x25m.

Valour 30mm is suitable for lawns, balconies & roof terraces, flat roofs, traffic islands, play areas and leisure, domestic and commercial projects.

4m x 1m = £91.15



Artificial Grass Joint Adhesive



Long-lasting adhesive that will be perfect for your new turf
The artificial grass glue is sold by the tube. Each tube will complete a 3.5m join and should be applied with a mastic gun.

£14.39

Joint Tape

Seamlessly join two pieces of grass together.
Use in conjunction with the joint adhesive.

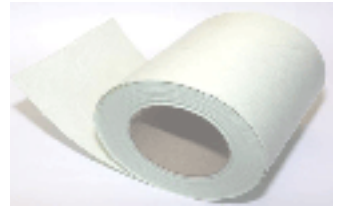

£2.40 per metre.



Garden Furniture

Garden Furniture can be the finishing touch you need to bring character and functionality to your open space. This creates opportunities for relaxation and socialisation within your home environment or public space.

At Littlewood Fencing, we can offer top quality garden products at competitive prices. Whether you're looking for benches or picnic tables, arches or arbours, there is something for everyone to make your garden stand out from the rest.

Ashton BBQ Shelter



The BBQ Shelter is the ideal addition to any garden when thinking of entertaining family and friends. With its panelled sides, open entrance and apex roof, it offers great protection for the chef and BBQ come rain or shine.

This product is the perfect garden feature offering shade or shelter whether you're hosting a party or simply relaxing outdoors.

Lily Relax Double Seat



The beautiful Lily Relax Double Seat is stylish and is ideal if you want comfortable and practical seating in any outdoor living space.

Having a fixed table between the seats, it is great for serving refreshments outside.

Alex Octagon Picnic Table



The classic picnic table has taken an unconventional approach in the Alex with its octagonal shaped table top. Perfect for entertaining a bigger party, the Alex Octagon Picnic Table can comfortably sit 8 people, and the octagonal shape allows for extra leg room while still offering an intimate dining experience.

Cambridge Planter



Made out of high quality pressure treated soft wood timber, the Cambridge Planter is design to be a distinctive feature for any garden. The unique design incorporates a diamond trellis back panel ideal for climbing plants and a steady base for planting.

For more information or a brochure request, contact our sales team
on 01424 775333 or
email us: sales@littlewoodfencing.co.uk

Sheds



Shire Sun Pent Range

Complete versatility is catered for by the choice of door and window layout provided in the styles available. By design additional headroom is afforded adjacent to the windows.

Shire Atlas Apex

Where to put the lawn mower and do some DIY?

The Atlas must be your answer, big enough for the ride on lawn mower and still space available for the large projects to be undertaken.



Sandringham Summerhouse

Double doors co-ordinate with our unique bay window to give the Sandringham character and quality matching opening side windows.



For more information or a brochure request, contact our sales team on 01424 775333 or

Chestnut Products

Why Chestnut?

Chestnut is a durable hardwood timber, sourced from local suppliers. It is ideal for gardens, paddocks, fields and parkland.

Item	Price
5'6" Stake	£2.64
6' Stake	£3.19
7'6" Strainer Pointed	£14.10
7' Strut	£5.04



Cottage Gates

Item	Price
1m Wide x 0.9m High	£55.20
1m Wide x 1.2m High	£60.00



Chestnut Post and Rail

Chestnut Post and Rail, sometimes known as 'Sussex Post and Rail' is a traditional and rustic style of fencing. Made from split Chestnut ended rails with noticed posts, it is sturdy and suited to a range of rural applications. It's known for its long lasting qualities. This type of fencing is relatively simple to install with minimal components or tools. Stock fencing can also be added to help contain smaller animals.



Item	Price
9'6" Cleft Rail Ended	£10.79
Cleft Post - Blank Inter / End	£9.60
Cleft Post - Blank Corner	£13.80
Mortice Charge for 2 Rail	£2.56
Mortice Charge for 3 Rail	£4.18

Littlewood Fencing is now set to offer customers an even wider choice of quality fencing and agricultural equipment after linking up with leading industry brand Ritchie Agricultural.



Established more than a century ago Ritchie offer a wide range of farming implements and equipment including solutions for livestock handling & care, grassland maintenance as well as yard equipment and machinery.

As the approved supply partner for the South East region, Littlewood Fencing now offer all Ritchie products from cattle crushes, stock cubes and feeding units to yard scrapers, bailers and accumulators.



Combi Clamp

- A large foot treadle allows the operator freedom of movement whilst restraining the animal for treatment
- The Combi Clamp width is fully adjustable to suit different sizes of sheep
- The Combi Clamp linage is adjustable to suit different weights of operator
- Easy use for dagging, drenching, vaccinating and tagging
- Simple non-return hock bar
- Can be set up for left or right hand operation



Stock Cube

- Portable or fixed applications
- Easily handled by forklift or pallet tines on front loader
- Easy to set - up and use
- Can transport up to 20 x 2.5m (8') cattle hurdles including pins
- Unique 'creeper' gate eliminates corner trap when operating the main sweep gate
- Easy access to and from the holding area
- Operator is behind the cattle and sweep gate whilst in operation



Metal Field Gates
on Page 26

Many More Items Available

As well as the products listed above, we can supply an array of feeders, animal management products, gates and farming essentials.

Speak to a member of staff today to find out more about the items we can supply.

Machine Rounds



A machine round post has a variety of different applications. Predominantly used in the agricultural industry for post and rail fencing around paddocks. They have now started to feature more in residential properties, with uses from tree stakes, low & high retaining walls or upright supports for wire netting. All our pointed machine rounds for ground use are Class 4 treated for a longer desired lifespan.



Post Diameter

	50mm	60mm	75mm	100mm	125mm	
Post Length	1.8m	£3.31	N/A	£4.34	£7.70 (FR) £3.76 (HR)	N/A
	2.4m	N/A	£3.59	£5.59	£9.89	£15.90
	3.66m	N/A	N/A	£7.50 (FR) £5.54 (HR)	£13.91 (FR) £6.52 (HR)	N/A

FR = Full Round, HR = Half Round

Stock Fencing

0.8m x 50m Roll	£63.46
0.8m x 100m Roll	£126.90
1.2m x 50m Roll	£72.46
0.8m x 100m (High Tensile)	£163.40



Line Wire

1.6mm 1 kg Galv (Tying Wire)	£11.94
2.5mm 5 kg Galv	£31.70
2.5mm 25 kg Galv	£57.03
3.15mm 5 kg Galv	£31.70
3.15mm 25 kg Galv	£57.03



Barb Wire

Barb Wire 200m - Normal	£46.31
Barb Wire 200m - High Tensile	£46.31
Flat Barb Wire Brackets	£12.76



Wire Netting

600mm x 25mm x 10m	£13.27
900mm x 25mm x 10m	£18.40
1.2m x 25mm x 10m	£24.80
1.05m x 31mm x 19g x 50m	£90.19
1.2m x 31mm x 19g x 50m	£113.29



Concrete

Concrete fencing products are increasing in popularity, they are a durable, robust and mostly maintenance free. Over the lifetime of the product they offer excellent value for money.



	Slotted Post	Morticed Post
1.8m Inter	£15.52	£18.73
1.8m Corner	N/A	£25.99
1.8m End	£18.66	N/A
2.1m Inter	£15.96	£21.12
2.1m Corner	£30.52	£28.51
2.1m End	£21.55	N/A
2.4m Inter	£16.68	£22.42
2.4m Corner	£30.98	£29.54
2.4m End	£23.86	N/A
2.7m Inter	£19.75	£26.49
2.7m Corner	£33.92	£33.07
2.7m End	£26.70	N/A
3.0m Inter	£35.75	N/A
3.0m Heavy Duty Inter	£50.23	N/A
3.0m Heavy Duty Corner	£57.89	N/A
3.0m Heavy Duty End	£86.64	N/A

Concrete Gravel Boards



Item	Price
1.83m G/Board Recessed 6"	£9.88
1.83m G/Board Recessed 12"	£16.00
2.4m G/Board 6"	£19.91
2.885m G/Board 6"	£23.30

Fixings	Price
6" Pin cleat	£2.24
12" Double Pin Cleat	£5.58
Roofing Bolt M8 x 80mm	£0.45
Square Plate Washer	£0.49

Concrete Repair Spurs

Item	Price
75mm x 75mm 1.0m Repair Spur	£8.12
100mm x 100mm 1.2m Repair Spur	£12.94

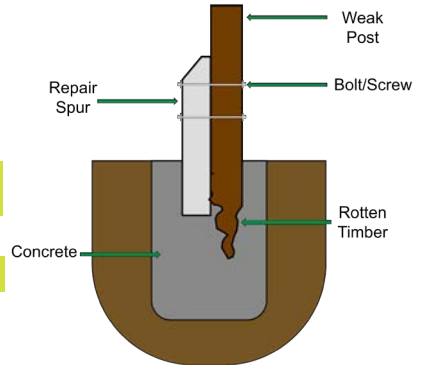

Coach Screw

Item	Price
M10 x 130mm Coach Screw	£0.68
M10 x 180mm Coach Screw	£0.95
50mm x 50mm M12 Square Washer	£0.49



Coach Bolt

Item	Price
M10 x 180mm Coach Bolt	£0.91
M10 x 240mm Coach Bolt	£1.32
50mm x 50mm M12 Square Washer	£0.49



Chain Link

Chain link Fencing is a mesh fence suitable for a variety of different uses from sports courts, garden boundaries, animal enclosures and light security fencing.

Chain link is supported by either concrete, timber or steel angle iron posts. The chain link itself is clipped onto a strained wire that runs between the upright supports.



Chain Link Type	Wire Thickness	Mesh Size	Height	Roll Length	Price
Galv	2.5mm	50mm	1.8m	25m	£204.00
Galv	3mm	50mm	1.8m	12.5m	£141.25
Green Plastic Coated	3.15mm	50mm	0.9m	25m	£98.98
Green Plastic Coated	3.15mm	50mm	1.2m	25m	£107.77
Green Plastic Coated	3.15mm	50mm	1.8m	25m	£162.90
Green Plastic Coated	3.15mm	50mm	1.8m	12.5m	£81.44
Green Plastic Coated	3.15mm	50mm	2.75m	12.5m	£157.73
Green Plastic Coated	3.15mm	50mm	3.6 m	12.5m	£229.70

Angle Irons

Painted or galvanised steel posts used for holding up chain link or other wire fencing systems. All our angle irons come painted black and are fitted with all the relevant fixings.

	Inter	End	Corner	2-Way
for 0.9m C/Link	£13.76	£59.08	£84.23	£84.23
for 1.2m C/Link	£15.83	£64.74	£101.33	£101.33
for 1.8m C/Link	£19.58	£76.82	£120.23	£120.23

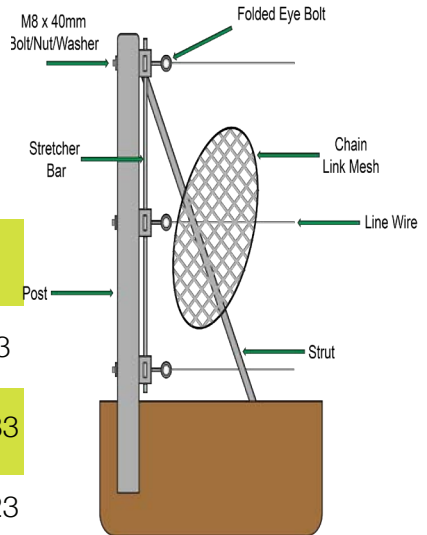

Stretcher Bars

Item	Price
Stretcher Bar 0.9m	£6.78
Stretcher Bar 1.2m	£8.66
Stretcher Bar 1.5m	£12.08
Stretcher Bar 1.8m	£13.12



Additional Fixings

Item	Price
Folded Eye Bolts 8"	£1.03
Folded Eye Bolts 10"	£1.06
Folded Eye Bolts 12"	£1.50
1.5" x 1.5" Angle Cleats	£0.54
2" x 2" Angle Cleats	£1.06
3 x 2 Angle Cleats	£1.59
3.5" Ferrule Winders	£1.40
Roofing Bolt M8 x 40	£0.34

Fencing Clips

Item	Price
Rapid Fence plier Gun	£27.19
Rapid Clips Galv F20 Box	£11.24
Rapid Clips Galv - Blister	£12.46
Rapid Clips Green - Blister	£13.72
Netting Clips per 200	£10.40
CL22 Clip Fast Rings 1000	£11.40

Security Fencing

A solution for property protection for everyday life. Security fencing is now the choice for applications requiring a secure premise for their home or business, where prevention against intruder access is a must.

There is no job too big or too small for security fencing, whether it is a boundary fence for a garden or a large scale industrial site. Here at Littlewood Fencing, we have the products, knowledge and expertise to make sure your premises are kept safe and secure.

Steel Palisade

Steel palisade fencing is predominately used around commercial premises requiring a higher level of security and vandal resistance. Steel palisade is popular for schools and industrial sites because of its high damage resistance and the fact it is difficult to climb. It is straight forward to install and very effective, with a choice of finishes available it makes this system suitable for a wide range of situations.

The palisade is available in two profiles 'W' profile and 'D' profile with a choice of heads; Round Nosed & Notched or triple pointed. The fencing is hot dip galvanised to prevent corrosion and in addition, can be powder coated (various colours available on request).



Security Fencing

Mesh Panel Fencing

Welded mesh panels are ideal for a wide variety of uses both residential and commercial. Generally installed as perimeter fencing around sports pitches, schools, construction sites, depots and other commercial or public sites.

The panels are strong, flexible, durable and are made up of closely spaced steel wires that make it difficult to grip or climb but allows very good visibility which helps it to merge well with the surrounding environment.

We can supply a range of sizes, thicknesses and styles to suit your individual needs and requirements.



Fabrication Workshop

Littlewood Fencing are now able to offer a range of steel fabrication services to our trade & retail customers. Our on site workshop has a wealth of experience having been established for over 10 years.

Past projects include high security site gates, post manufacturing & alterations, pedestrian & vehicle barriers, fencing tool repairs and much more.

Please get in touch for further information.



Fabrication Workshop



Tools & Fixings

To complete your outdoor garden project we can supply the necessary fixtures, fittings and tools to ensure your finished project is perfect in every way.

We offer a complete 'One Stop Shop' service from supply to advice on a trouble free installation to transform your garden into a stylish and individual environment.

With our expert product knowledge and experience of the industry, we are constantly improving and updating our selection of practical and innovative tools and fixings. We hope you enjoy selecting from our comprehensive range.

We all know it's those finishing touches that can make all the difference.

Nails & Staples

	0.5kg	1kg	2.5kg	5kg	10kg	20kg	25kg
Round Wire Head Nails (40-125mm)	£4.56	£6.83	£16.91	£26.44	N/A	N/A	£68.82
Staples (25-40mm)	£4.12	£10.70	£21.39	N/A	£47.93	£95.86	N/A

Wood Screws

	30mm	40mm	50mm	60mm	70mm	80mm	90mm	100mm	120mm
4mm	£3.02	£3.84	£4.79	£5.99	£6.93	N/A	N/A	N/A	N/A
5mm	£4.98	£5.99	£7.18	£4.41	£5.14	£5.92	£6.93	£7.31	£9.07
6mm	N/A	£7.56	£8.19	£8.51	£8.69	£8.69	£10.46	£11.66	N/A

Box Qty 200

Box Qty 100

For Decking Screws and Landscaping Screws
See Page 31

Coach Screws



	50mm	80mm	100mm	130mm	150mm	180mm	200mm
M8	£0.23	£0.30	£0.38	N/A	£0.53	N/A	N/A
M10	£0.30	£0.38	£0.49	£0.68	£0.77	£0.95	£1.13

Coach Bolts



	75mm	80mm	100mm	160mm	180mm	200mm	220mm	240mm
M10	N/A	£0.52	£0.59	£0.87	£0.91	£1.05	£1.07	£1.32
M12	£0.79	N/A	£0.87	N/A	N/A	N/A	N/A	N/A

Roofing Bolts



	25mm	40mm	80mm	100mm	140mm	160mm	180mm
M8	£0.26	£0.34	£0.45	£0.57	£0.83	£0.91	£0.95

Thunder Bolts



	60mm	75mm	100mm	150mm
M8	£0.57	£0.69	£0.86	£1.20
M10	N/A	£0.95	£1.26	£1.83

For more information on different sizes please contact our sales team on 01424 775333 or email us: sales@littlewoodfencing.co.uk

Approved Installers

For domestic installation services, please get in touch with one of the following local companies.



Sean Kirk

Tel: 01424 892388

Mob: 07762 794997

Email: seankirkfencing@outlook.com

www.seankirkfencing.co.uk



Daniel Auer

Tel: 01424 583255

Mob: 07432 448914

Email: info@dandhfencing.co.uk

www.dandhfencing.co.uk



[dandhfencinglandscaping](https://www.facebook.com/dandhfencinglandscaping)



[dh_fencing-landscaping](https://www.instagram.com/dh_fencing-landscaping)



Approved Installers



David Warne

Tel: 01424 257546

Mob: 07753553429

Email: davidwarne@live.co.uk

www.djwarnelandscaping.com



D J Warne Landscaping

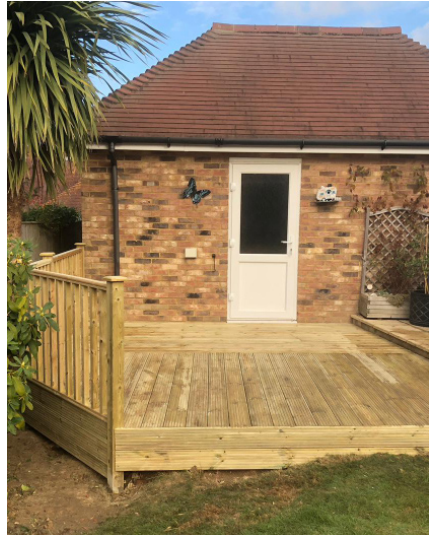

John French

Tel: 01424 830225

Mob: 07768221150

Email: julia.l.french@btinternet.com



Hand Tools

Whether you are putting up closeboard, installing a run of wire fencing, building a garden building or simply cutting timber, we have the tools you need. We stock a huge range of quality fencing, carpentry and garden tools.

Littlewood staff know our products well and can help you to find and decide on what tool is right for the job, so pop in today to have a better look.



Power Tools

Power tools are available to order from a wide range of manufacturers with a fast delivery time. Whether you are looking for Makita, Dewalt, Milwaukee, or any other leading manufacture. Servicing on nails guns also available.



Paint and Treatment

Over time the English climate deals out a lot of punishment to timber products such as sheds, fences, decking and planters. This can lead to discolouration and eventually rot if left to the elements. Therefore here at Littlewood we stock specialist paints, oils and treatments that are specifically designed to protect your timber from the weather. We have a large amount of different colours and tints to suit your personal space and garden decor and if you can't find the shade you're looking for we can order a wide range from our suppliers.



Company Policies on Returns, Delivery & Bespoke Items

Returns

Returned goods are subject to the following conditions

- Returns within 30 days of purchase
- Proof of purchase required (original invoice)
- Refund will be made by the same method as the original payment
- Goods unused and in original condition when they left the yard
- A re-handling charge of 25% may be incurred on any products being returned

Delivery

- Free local * delivery for orders of a minimum value of £200 plus VAT
- Additional delivery costs may apply to orders that require a crane offload
- Delivery drops are curb side / front driveway only
- Damaged, Shortage or Incorrect Products must be reported to the sales office within 5 working days

Bespoke Items

- Any custom items must be paid for in full prior to any work being undertaken
- All bespoke items to have signed agreement on details / measurements
- Bespoke items are non refundable

* Speak to a member of the sales team to enquire if your delivery address qualifies for a local area delivery

Find Us



Address

Littlewood Fencing Ltd
Beechdown Sawmill
North Trade Road
Battle
East Sussex
TN33 9LJ

Hours

Mon - Fri: 7:30 - 17:00
Saturday (Oct-Feb): 8:00 - 12:00
Saturday (Mar-Sep): 8:00 - 13:00
Sun: Closed

Contact Us



01424 775333



www.littlewoodfencing.co.uk



sales@littlewoodfencing.co.uk



[@littlewoodfencing](https://www.facebook.com/littlewoodfencing)

